

Installation Instructions

Model Aurora™ Plus Walk-In Door



Contractors Wardrobe®

DESIGNERS • MANUFACTURERS • TOLL FREE: (800) CW-DOORS • (800) 293-6677 • www.cwdoor.com
26121 Avenue Hall • Valencia, CA 91355 • (661) 257-1177 • FAX: (661) 257-4907

Illustrated Parts Breakdown (IPB) Model Aurora™ Plus Walk-In Door

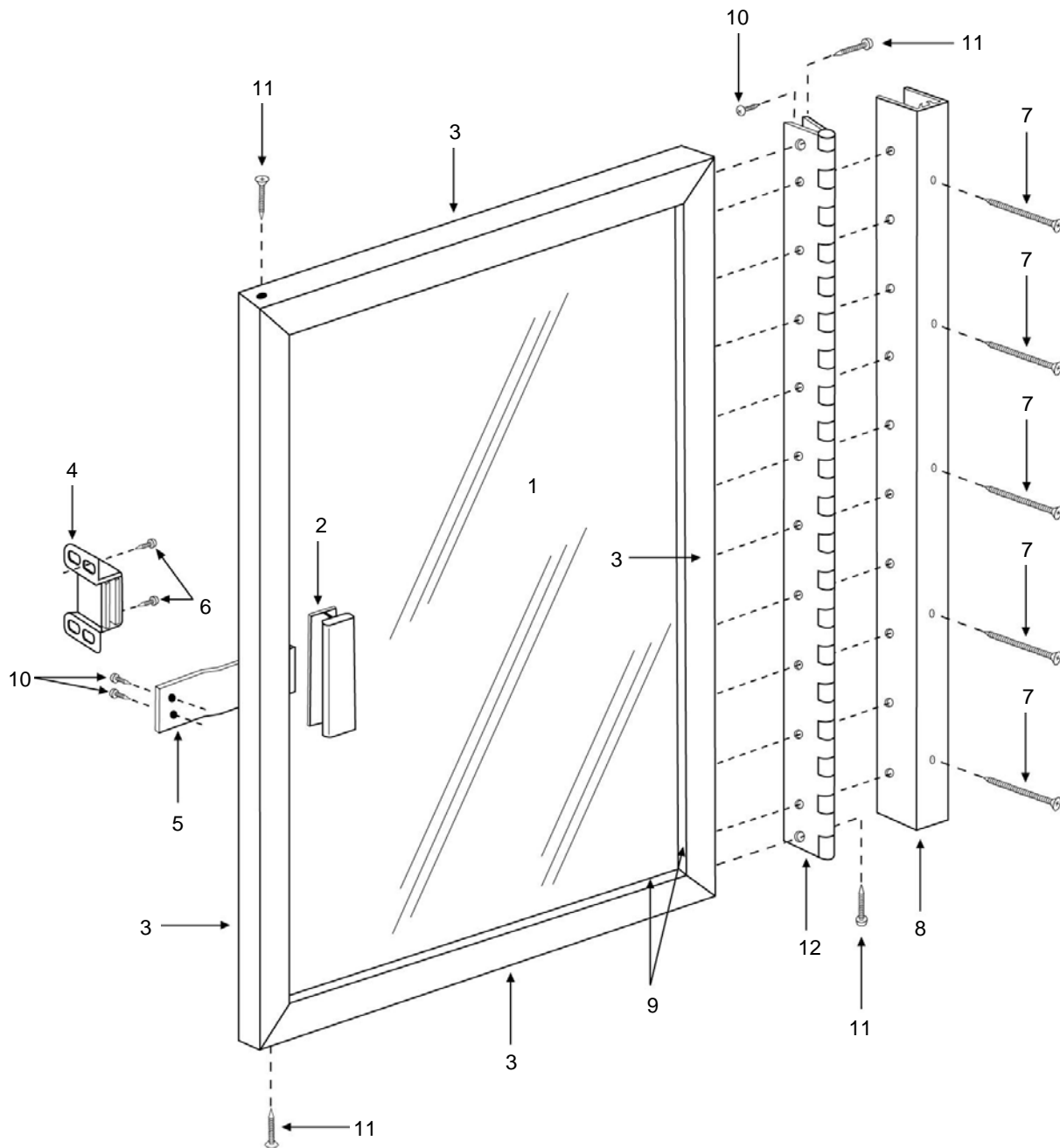

No.	QTY	PART #	PART DESCRIPTION
#1	1		Aluminum Framed Mirrored Wardrobe Door with Hinge Assembly
#2	1	HMSW1	Mirror Handle
#3	1	A3700	Aurora™ Aluminum Frame Mold
#4	1	C1010	Magnetic Catch
#5	1	P9090	Magnetic Catch Plate with 2-way tape
#6	2	S0130	#6 x 3/4 Magnetic Catch Screw

No.	QTY	PART #	PART DESCRIPTION
#7	5	S0110	#8 x 2-1/4 Installation Screw
#8	1	A3700	Aluminum Mounting Strip
#9	4	G1010 Gray	Glazing Vinyl
#10	26	S0080	#6 x 1/4 PH SMS Screw
#11	4	S0075 Silver	#8 x 3/4 PH SMS Screw
#12	1	H6060	Piano Hinge

Congratulations on purchasing your new CW® Wardrobe Door. Now that you have opened the package, we want you to verify that you have all the necessary hardware supplied with your doors.

PARTS CHECK LIST:

No. Qty. Description

(#1) 1 Aluminum Framed Mirrored Wardrobe Door with Hinge Assembly

(#2) 1 Mirror Handle

(#4) 1 Magnetic Catch

(#5) 1 Magnetic Catch Plate with 2-way tape

(#6) 2 #6 x 3/4 Magnetic Catch Screw 

(#7) 5 #8 x 2-1/4 Installation Screw 

(#10) 2 #6 x 1/4 PH SMS Screw 

If you find that any parts are damaged or missing, refer to the parts list and the IPB Drawing and contact Contractors Wardrobe®'s Customer Service Department at 661-257-1177.

TOOL CHECK LIST:

You will need:

- Phillips Screwdriver
- Level
- Electric Drill plus 1/8 and 7/64 Drill Bits
- Pencil
- Hammer and Nail
- Two (2) Wood Blocks 1/2 - 3/4 thick (not supplied)
- Two (2) Shims approximately 1/8 thick (not supplied)
- Five (5) Molly Bolts (not supplied, however it may be necessary. See below "IMPORTANT" paragraph)

NOTE: The Wood Blocks are used to support the Wardrobe Door (#1) during installation. To determine the size of these Wood Blocks, see **Step 3: Determining Door Clearance.**

IMPORTANT: The Wardrobe Door (#1) should be installed so that the Installation Screws (#7) go into wall studs. If the installation requires you to install the Wardrobe Door (#1) onto drywall only, we *strongly* recommend that you use **Toggle or "Molly" Bolts** (not supplied) for this installation.

STEP 1 Removing the Existing Door and Door Trim/Molding

Remove the existing door and all existing hardware from the Wall. If you prefer, the wardrobe door *can* be installed over any existing flat wall or trim. However, we recommend that you remove the existing door opening trim/molding so that the Wardrobe Door (#1) will install on the flat wall/framing. This may require paint touch-up where you have removed the door trim.

STEP 2 Determining the Hinge Side

Decide which side you want the door to open from: left or right. Our illustrations show how to install the Wardrobe Door (#1) to open on the left, with the Piano Hinge (#12) and Aluminum Mounting Strip (#8) on the right.

STEP 3 Determining Door Clearance

- A. Locate two Wood Blocks whose dimensions will raise the Wardrobe Door (#1) 1/2 - 3/4 off the floor surface or carpet (See Figure 1). It will also be helpful to have on hand a few thin wood strips or "shims" in case you need to adjust the height and alignment of the Wardrobe Door (#1) as you go.

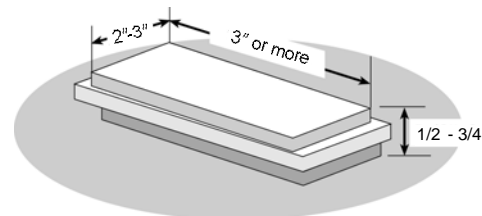

Figure 1

- B. Set the Wood Blocks as shown in Figure 2, with the Wood Blocks positioned in the doorway so that the Wardrobe Door (#1) can set securely on them.

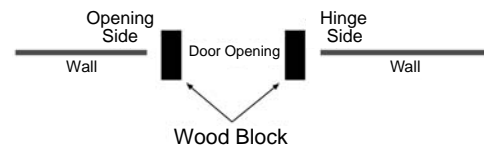

Figure 2

- C. Lift the Wardrobe Door (#1) so that the mirror front is *facing* you and the Piano Hinge (#12) is on your right. Set the Wardrobe Door (#1) on the Wood Blocks with the Aluminum Mounting Strip (#8) touching the wall at the Wardrobe Door (#1) supported on the Wood Blocks (See Figure 3). The Wardrobe Door (#1) and Aluminum Mounting Strip (#8) should be flush to the wall.
- D. Refer to Figure 3. Use the Level to align the Wardrobe Door (#1) and Aluminum Mounting Strip (#8) plumb, straight up and down. The "shims" may come in handy for this purpose.

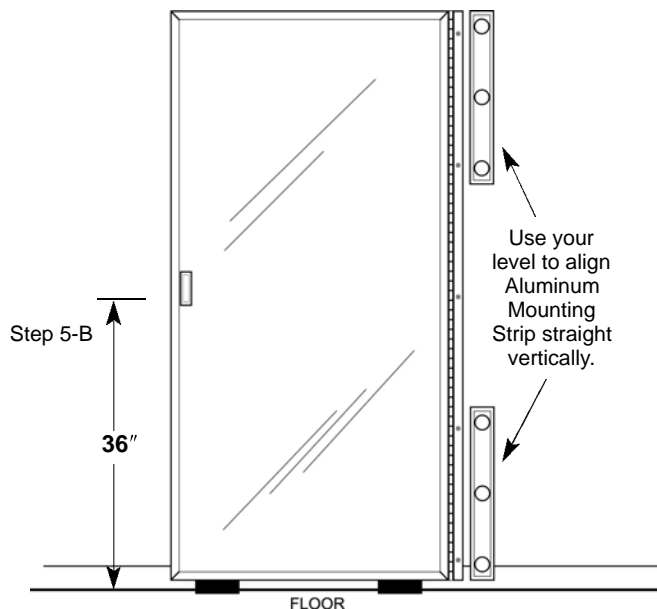

Figure 3

STEP 4 Installing the Door

- A. Locate the five #8 x 2-1/4 Installation Screws (#7).
- B. Hold the Wardrobe Door (#1) in place with one hand while you complete the next step. Using the 1/8 Drill Bit, carefully use the pre-drilled hole at the **TOP** of the Aluminum Mounting Strip (#8) and drill through the hole and into the door frame studs. Remember, you want to be securing the Wardrobe Door (#1) to wall stud. If you are not able to install the Wardrobe Door (#1) into a stud, please use Toggle or "Molly" Bolts (not supplied) in place of the #8 x 2-1/4 Installation Screws (#7). Use one #8 x 2-1/4 Installation Screw (#7) and the Phillips Screwdriver to secure the Wardrobe Door (#1) to the wall. **DO NOT** tighten the #8 x 2-1/4 Installation Screw (#7) completely at this time.
- C. Next, use the Level to check plumb again. In the bottom-most pre-drilled screw hole, use the 1/8 Drill Bit and carefully drill through the door framing. Use another #8 x 2-1/4 Installation Screw (#7) to secure the Wardrobe Door (#1) to the wall.
- D. Use the remaining #8 x 2-1/4 Installation Screws (#7) to finish securing the Wardrobe Door (#1) to the wall. Firmly tighten all five #8 x 2-1/4 Installation Screws (#7).

STEP 5 Installing the Mirror Handle

- A. Locate the Mirror Handle (#2).
- B. Thoroughly clean the mirror on the side of the door that opens. Peel the paper backing off of the back of the Mirror Handle (#2) and press it firmly onto the mirror, 36 up from the bottom of the Wardrobe Door (#1) so that it just touches the Glazing Vinyl (#9) (See Figure 3).

STEP 6 Installing the Magnetic Catch and Magnetic Catch Plate

NOTE: Our illustration shows how to install the Magnetic Catch Plate with 2-way tape (#5) immediately behind the Mirror Handle (#2). However, if you prefer, feel free to install the Magnetic Catch (#4) and Magnetic Catch Plate with 2-way tape (#5) anywhere along the edge of the Wardrobe Door (#1).

- A. Locate the Magnetic Catch (#4), Magnetic Catch Plate with 2-way tape (#5), two #6 x 1/4 PH SMS Screws (#10), two #6 x 3/4 Magnetic Catch Screws (#6) and the 7/64 Drill Bit.
- B. Open the door. Clean the backing where the plate will be taped. Peel the backing off of the 2-way tape on the Magnetic Catch Plate (#5). On the back of the door's Aluminum Frame Mold (#3), immediately behind the Mirror Handle (#2), align the bent end of the Magnetic Catch Plate with 2-way tape (#5) and press the 2-way tape against the backing of the Wardrobe Door (#1). Refer to the IPB drawing for assistance. Use a 7/64 Drill Bit to very carefully drill two holes through the Magnetic Catch Plate with 2-way tape (#5) and into the Aluminum Frame Mold (#3). Secure the Magnetic Catch Plate with 2-way tape (#5) to the back of the Wardrobe Door (#1) with the two #6 x 1/4 PH SMS Screws (#10) (See Figure 4).

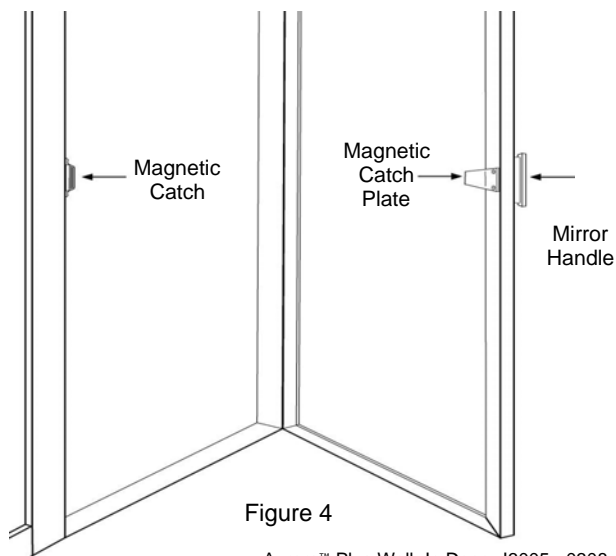

Figure 4

- C. The Magnetic Catch (#4) will be installed directly behind the Magnetic Catch Plate with 2-way tape (#5). With the Wardrobe Door (#1) closed, make a small pencil mark on the wall, centered on the Magnetic Catch Plate with 2-way tape (#5) (See Figure 5).

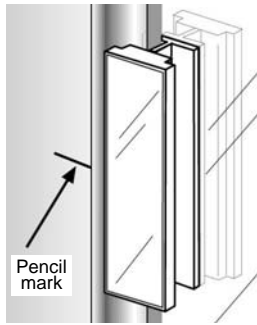

Figure 5

- D. Open the Wardrobe Door (#1) and step into the doorway. Position the Magnetic Catch (#4) so that the magnets are facing out, flush with the face of the wall and centered on the pencil mark as shown in Figure 6.

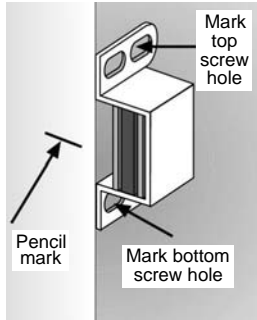

Figure 6

- E. Now, use your pencil to mark the position of only two of the screw holes, one top and one bottom, in the Magnetic Catch (#4) brackets (See Figure 7).

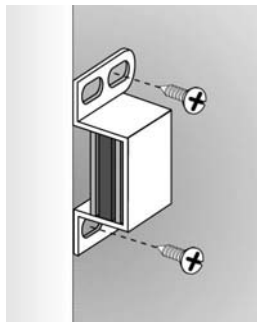

Figure 7

- F. Using a Hammer and Nail, tap a hole at each mark. Use a Phillips Screwdriver and the two #6 x 3/4 Magnetic Catch Screws (#6) to secure the Magnetic Catch (#4) inside the doorway.

Thank you for purchasing a CW® Wardrobe Door. This is only one of a large line of wardrobe doors and high quality bath enclosure products. If you like this product, please contact Contractors Wardrobe® for more information about our many beautiful bath enclosures available in a vast array of colors and finishes to suit your designing needs.